

S-7300A

Single Needle Direct Drive Lock Stitcher with Electronic Feeding System and Thread Trimmer

The world's first lock stitch sewing machine which adopts the Electronic Feed Control directly connected with a stepping motor.

Next-generation lock stitch machine, which establishes the new standard, has been born.

- High quality sewing
- Reduction of disposition of thread ends
- Equipped the color LCD touch panel for intuitive operation
- Offers a new value with Design Stitch
- Enhances the operability with new Hand Switch



NEXIO

NEXIO

Brother Continues to Drive a New Era of Product Excellence and Industry Change

Since its inception in 1908, Brother has been at the forefront of product innovation, dedicated to delivering superior and innovative sewing technology to our customers.

While these innovative changes have now become the industry standard, our never-ending spirit of challenge and innovation inherited from our ancestors have helped us surmount many challenges in the marketplace and continue striving for product excellence.

It is with this spirit of pride and dedication that we introduce our new line of NEXIO industrial sewing machines.

This new line of NEXIO industrial sewing machines boasts a new feeding mechanism and striking new housing that will set a new design standard in the industry.

This new brand name is derived from the words "Next" and "Society," combining our vision to drive a new era of industry change with continual dedication to innovative product development, as well as our continued company commitment to forging strong customer relationships by being "At your side."

Driving a New Era of Sewing Technology

The world's first lock stitch sewing machine which adopts the Electronic Feed Control directly connected with a stepping motor. Next-generation lock stitch machine, which establishes the new standard, has been realized.



1 World's first Electronic Feed Control directly connected with stepping motor

Horizontal feeding system is world's first computerized for single needle lock stitch sewing machine. The feed motion can be changed with one touch of a button to provide best sewing quality for various materials. Furthermore, the sewing stitch length can be digitalized, stabilizing the stitches. (Patent applied)

	Feed motion image
Standard Oval feed	
NEW Front rise feed	
NEW Back rise feed	
NEW Rectangular feed	

2 Reduction of Disposition of Thread Ends (Premier Spec.)

Minimizes the bird's nest at sewing start and short remaining thread min.3mm

With the new thread tension control and electronic feed control, the bird's nest can be minimized. The new double action thread trimming mechanism cut the thread right under the needle hole, realizing the short remaining thread at minimum 3mm. The disposition of thread ends after sewing can be reduced thanks to the new system. (Patent applied)

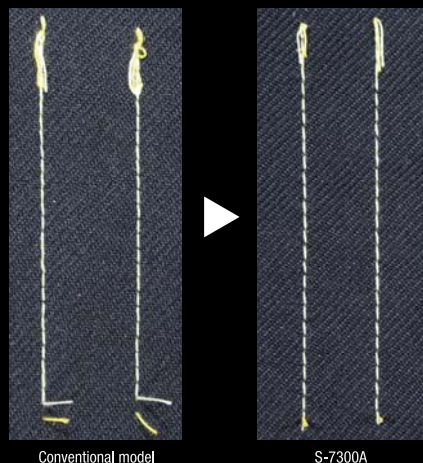

3 Design Stitch for new value proposition

Thanks to the digitalized feeding system, you can change the stitch length on the same seam by program control. Now design stitch is available for even single needle lock stitch machine easily. (Design applied)



4 LED Light Equipped as Standard

Both-sides of the LED handy light are equipped as standard for better operation, preventing shadows on the garment. The brightness can be adjusted on the panel.



5 Clogging at cross-over seam reduction (Premier Spec.)

Automatic material thickness sensor detects the thickness while sewing, helping to reduce clogging at cross-over seam and needle breakage. S-7300A enables to correct stitch length automatically, when sensor has been detected cross-over seam, offering stable stitch length and high quality sewing for even unskilled-operator. (Patent applied)

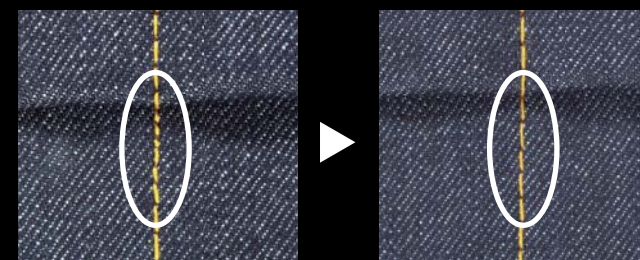

6 Clean sewing with minimum lubrication system

You can choose minimum lubrication system or semi dry type. Oil leakage from the needle bar area can be prevented, realizing clean sewing and stain free garments.

7 Needle Breakage Prevention Function Is Enhanced

The needle breakage prevention function which prevents the needle breakage when reverse stitching is carried out with the actuator switch (Patent acquired). Furthermore, the electronic feed control, the needle breakage while sewing is also prevented.

8 The new hook enhances sewing capability for a wide range materials

The new hook which is improved the thread cast off enables to expand sewing range for medium materials. It also enhances the sewing capability for heavy materials.

	Medium materials	Heavy materials
Conventional Model		
S-7300A		

A

User-intuitive Color LCD with Touch Panel

Equipped the Color LCD with touch panel and indicates display items with illustration icons, offering user-intuitive operation.

For panel display, Easy mode Home(for operators) and Detailed mode Home(for mechanics) are available. Each mode is highlighting the necessary and useful functions according to the users so they can grasp the needed information at a glance. Switching those modes can be set on the panel.

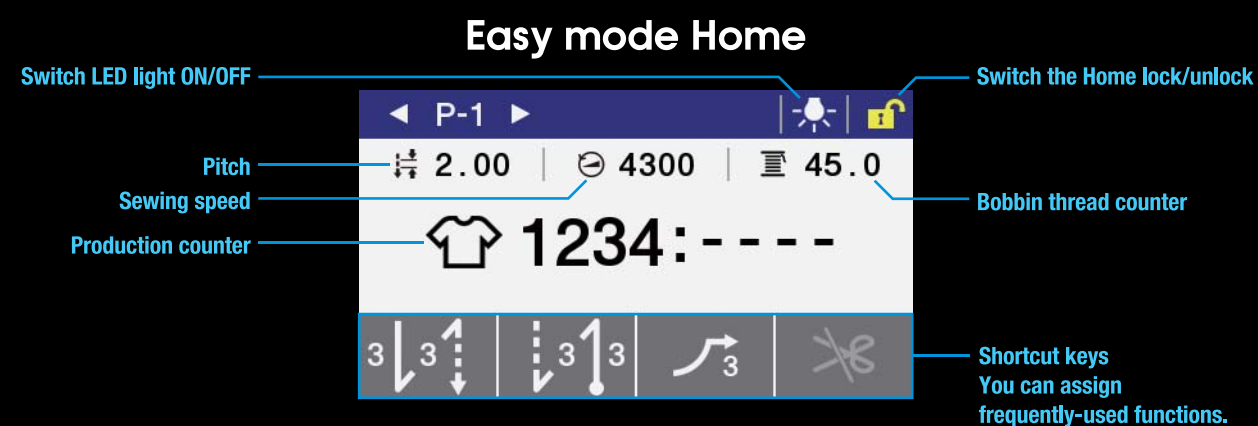
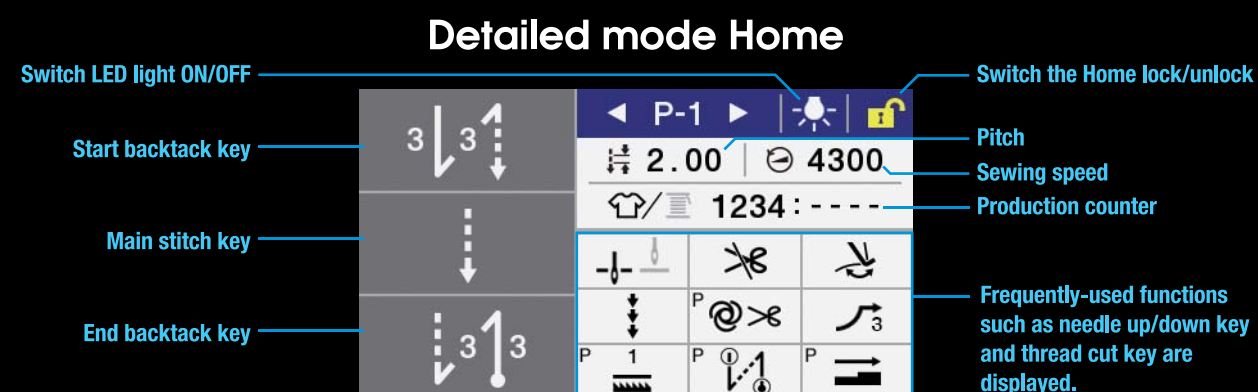

Feed Motion Change P 1
You can select the feed motion type from 4 kinds of motions.

Sewing Pattern Setting
Up to 9 sewing patterns can be easily set and stored with this function.

Protect Mode
The stitch length and sewing speed can be locked together.

Best Performance Mode
(Minimizes the bird's nest and remaining short thread)
When the mode is set ON, it is effective for reduction of thread run out and remaining short thread.

Easy sewing pattern programming
Setting of sewing step such as pocket sewing is easy to set on the panel. Up to 20 steps can be stored.

Error Message Display
When an error occurs, the error message and solution are displayed on the panel.

Switchable Stitch length unit
The stitch length unit can be switched on the panel as followings.
0: mm
1: Stitch per inch
2: Stitch per 30mm

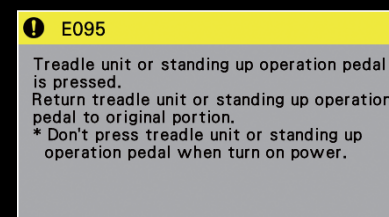
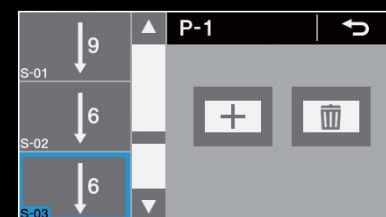

B

Useful functions are gathered in the hand switches

Useful functions are easily carried out with the 2 hand switches. You can assign the functions to each switch, so various useful functions are available with a combination of the switches. Assigning the functions are set on the panel.

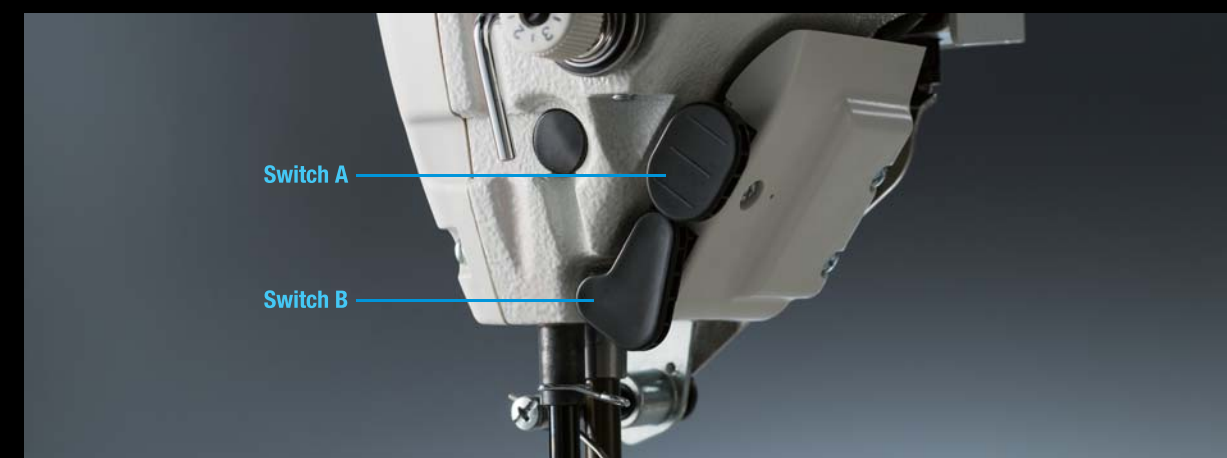

The compensation stitch with a half-length stitch available for better corner sewing

You can use both Switch A and B each for compensation stitch and half pitch compensation stitch as sewing portion. When sewing the corner of jeans, for example, you can use half-pitch in order to align the stitch on the corner. S-7300A reduces operator's work load by changing the manual operation to be digitalized.



Production counter manual count up/down
When the Hand switch A is pressed, the production counter increases by 1 each time.

C

USB Port is Equipped

The USB port is equipped so sewing patterns and environmental settings can be copied easily to other sewing machines. Also, you can upgrade the software with USB memory.



Design Stitch for new value proposition

Thanks to the digitalized feeding system, you can change the stitch length on the same seam by program control. Now design stitch is available for even single needle lock stitch machine easily. (Design applied)



Specifications/

S-7300A- ■■■

S-7300A- ■■■P

	Thread wiper	Lubrication type	Application	Specification
3	—	0 Minimum lubrication	3 For medium-weight materials	P Premier Specification
4	✓	3 Semi dry	5 For heavy-weight materials	

S-7300A	-303, -403	-305, -405	-333, -433	-303P, -403P	-305P, -405P	-333P, -433P
Lubrication type	Minimum lubrication	Minimum lubrication	Semi dry	Minimum lubrication	Minimum lubrication	Semi dry
Application	Medium materials	Heavy materials	Medium materials	Medium materials	Heavy materials	Medium materials
Max. sewing speed	Stitch length 4mm and under : 5,000sti/min Stitch length 4mm and above : 4,000sti/min	Stitch length 4mm and under : 4,500sti/min Stitch length 4mm and above : 4,000sti/min	Stitch length 4mm and under : 5,000sti/min Stitch length 4mm and above : 4,000sti/min	Stitch length 4mm and under : 5,000 sti/min Stitch length 4mm and above : 4,000 sti/min	Stitch length 4mm and under : 4,500 sti/min Stitch length 4mm and above : 4,000 sti/min	Stitch length 4mm and under : 5,000 sti/min Stitch length 4mm and above : 4,000 sti/min
Max. Back tacking speed	3,000 sti/min			3,000 sti/min		
Max. stitch length	5mm	Max. 7mm (default setting : 5mm)	5 mm	5mm	Max. 7mm (default setting : 5mm)	5 mm
Thread trimming mechanism	Single action thread trimming mechanism (Ordinary type)			Double action thread trimming mechanism		
Automatic material thickness sensor	—	—	—	✓	✓	✓
Presser foot height	Presser bar lifter: 6mm, knee lifter: 13mm			Presser bar lifter: 6mm, knee lifter: 13mm		
Needle bar stroke	31mm	35 mm	31 mm	31mm	35 mm	31 mm
Needle (DBx1 • DPx5)	#11-#18(Nm75-110)	#19-#22 (Nm120-140)	#11-#18 (Nm75-110)	#11-#18(Nm75-110)	#19-#22 (Nm120-140)	#11-#18 (Nm75-110)
Height of feed dog	0.8mm	1.2mm	0.8mm	0.8mm	1.2mm	0.8mm
Weight	34.5kg			34.5kg		
Motor	AC servo motor			AC servo motor		
Power supply	100V-110V(*1), 200-230V, 380-400V(*1) under 450VA			100V-110V(*1), 200-230V, 380-400V(*1) under 450VA		

*1 The transformer is required.

Optional parts / Reverse wiper device <SB6523001>



RoHS Compliant

S-7300A is compliant with the RoHS Directive (the restriction of the use of certain hazardous substances in electrical and electronic equipment) which came into effect in the EU in July 2006.



Brother has established voluntary environmental standards for products and created the "Brother Green Label".

S-7300A is certified as an environment-conscious sewing machine according to the "Brother Green Label" standard.



Working with you for a better environment
www.brotherearth.com

Please read instruction manual before using the machine for safety operation.

-Product specifications are subject to change for improvement without notice.

-Photographs are for illustration purpose. They may not represent actual operating conditions and may display optional parts.

CHINA
ASIA
EUROPE AFRICA, MIDDLE EAST
AMERICAS

BROTHER MACHINERY SHANGHAI LTD.
BROTHER MACHINERY (ASIA) LTD.
BROTHER INTERNATIONALE INDUSTRIEMASCHINEN GmbH
BROTHER INTERNATIONAL CORPORATION

<http://www.brother.cn/> +86-21-3135-3355
<http://www.brother.com.hk/> +852-2777-0010
<http://www.brother-ism.com/> +49-2822-6090
<http://www.brother-usa.com/> +1-908-704-1700



BROTHER INDUSTRIES, LTD.

1-5, Kitajizoyama, Noda-cho, Kariya-shi, Aichi 448-0803, Japan.
Phone: 81-566-95-0088 Fax: 81-566-25-3721 <http://www.brother.com/>

2015.6 15031044B Vol.2